

INSTALL INSTRUCTIONS FOR 75-6000

PART#: 75-6000 / 75-6000D

Vehicle Application

YEAR: 2011-2016

MAKE: Ford

MODEL: F-250/F-350

ENGINE: 6.7L Powerstroke

Tools Required

- Socket Wrench
- 8mm, ½" Socket
- 5/16" Nut Driver or Flat Blade Screwdriver
- Panel Popper
- T20 Torx
- Phillips Screwdriver
- Scissors

S&B Filter Maintenance

KF-1070 Cotton Cleanable : If the filter included with your intake kit is RED with a black cage, it came pre-oiled from the factory.

KF-1070R Dry Cleanable : If the filter included with your intake kit is WHITE with a black cage, it is a Dry Cleanable filter and can be cleaned up to 10x before discarding. This filter does not require oil. [Click here for the cleaning instructions.](#)

Note: Approximate Install Time: 1 Hour

CARB Status - 50 State Street Legal

CARB EO # D-590-23

Before You Start

- Please read the entire product guide before proceeding.
- Ensure all parts are present.
- If you are missing any of the components, call our customer support at (909) 947-0015.
- Do not work on your vehicle while the engine is hot.
- Make sure the engine is turned off and the vehicle is in Park or the Parking Brake is set.

Related Products

- Cotton Cleanable Filter (KF-1070)
- Dry Cleanable Filter (KF-1070R)
- Cleaning & Oiling Kit (88-0008)

EXPLODED VIEW - PARTS LIST

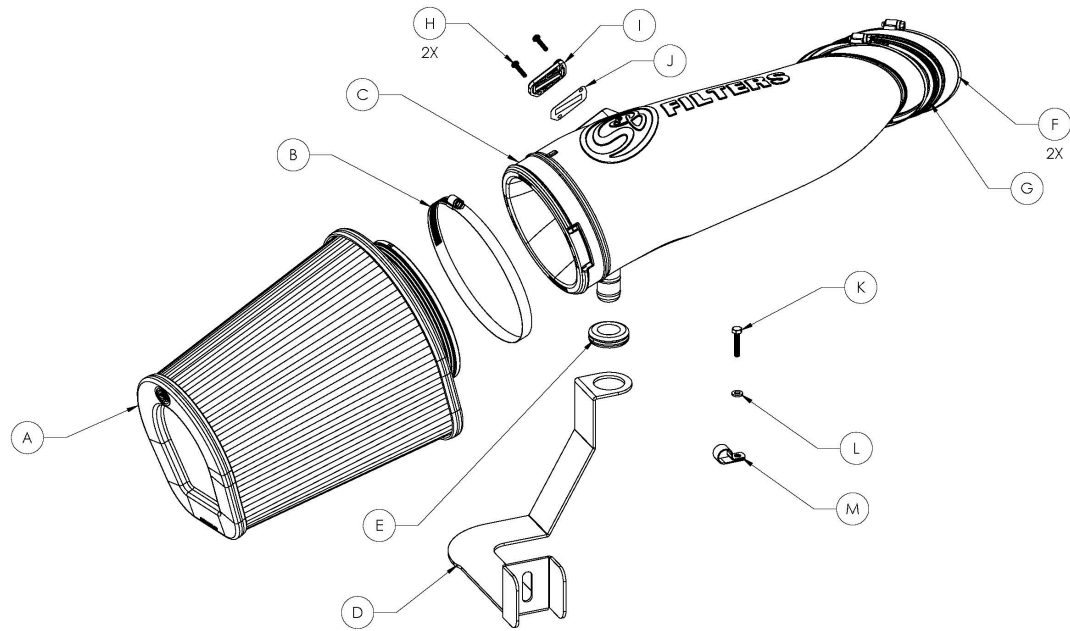

ITEM NO.	PART NUMBER	DESCRIPTION	QTY.	ITEM NO.	PART NUMBER	DESCRIPTION	QTY.
A	KF-1070	Air Filter	1	H	A11837-00	8-32 Thread Size, 3/4" Long Screw	2
B	AG1012-00	Hose Clamp, #104	1	I	A11822-00	MAF Adapter Pad	1
C	AL1344-00	Intake Tube	1	J	A11823-00	MAF Gasket	1
D	AI2173-00	Intake Tube Support Bracket	1	K	A11257-00	HHCS, M6 x 10mm	1
E	AI1368-00	Rubber Grommet	1	L	A11416-00	M6 Washer	1
F	AG1009-00	Hose Clamp, #72	2	M	A11511-00	Loop Clamp, 5/8" OD x 1/2" Wide	1
G	AI1523C-00	Straight Coupler	1				

INSTALLATION STEPS

STEP 1

With the ignition switched off and the parking brake set. Disconnect the negative battery cables on both batteries and the positive battery cable on the passenger side battery.

IMPORTANT: Failure to disconnect the battery for a minimum of 2 hours may cause the Check Engine Light to illuminate upon completion of the installation or subsequent operation. DO NOT SKIP THIS STEP!

Tools Required: Socket Wrench, 8mm Socket.

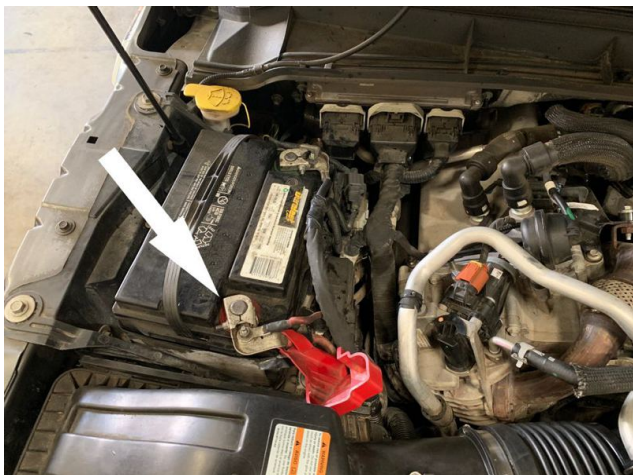

STEP 2

Disengage the red locking clip, press down on the tab, then pull out to disconnect the MAF sensor harness from the MAF sensor. Unclip the wiring harness from the stock intake lid.

Tools Required: Panel Popper



STEP 3

Loosen the hose clamp at the intake tube and remove the screw securing the air box to the battery tray. Tools Required: Socket Wrench, 8mm Socket



STEP 4

Loosen the hose clamp at the turbo inlet and remove the screw securing the stock intake tube. Tools Required: Socket Wrench, 8mm Socket

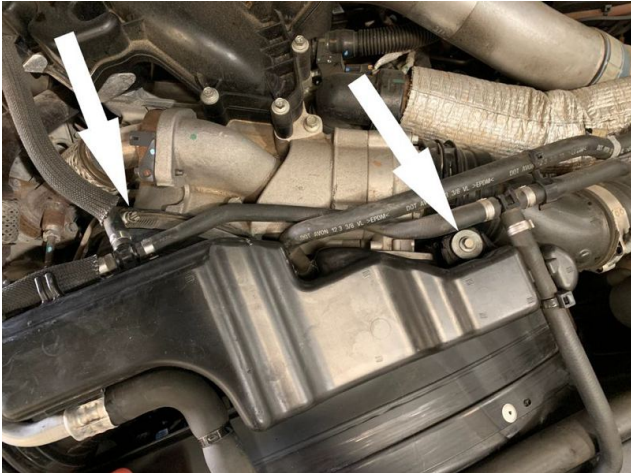

STEP 5

Disconnect all the rubber hoses and coolant lines from the intake tube.



STEP 6

Lift the stock air box up to unseat the grommets from the air box tray and remove the stock air box from the vehicle.



STEP 7

Remove the stock intake tube from the vehicle by removing the coupler from the turbo inlet, twisting it into the position shown, and pulling it out from underneath the metal coolant line.

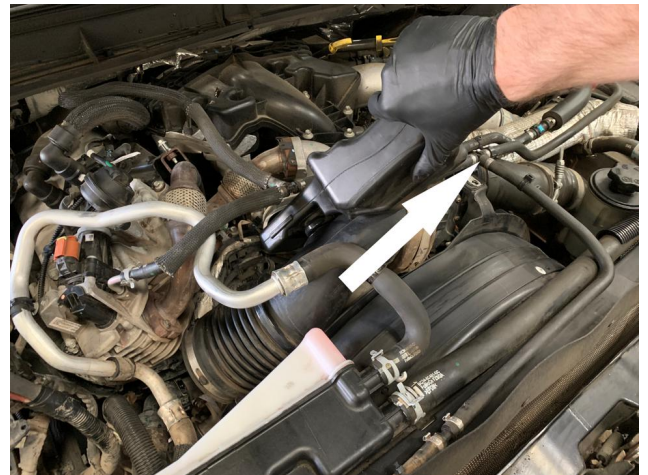

STEP 8

Remove the two screws securing the bracket under the airbox which holds the grommets to seat the airbox. Then remove the bracket from the vehicle. We will reuse one of the removed screws in step 10. Tools Required: Socket Wrench, ½" Socket

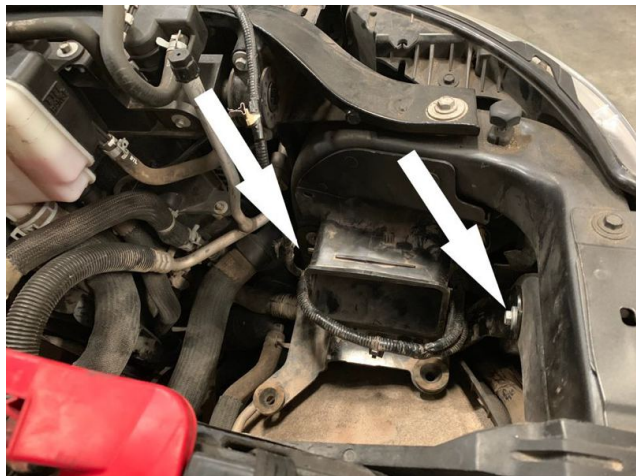

STEP 9

Looking at the top of the engine bay, remove the indicated 4 screws securing the grill to the vehicle.

Tools Required: Socket Wrench, 10mm Socket

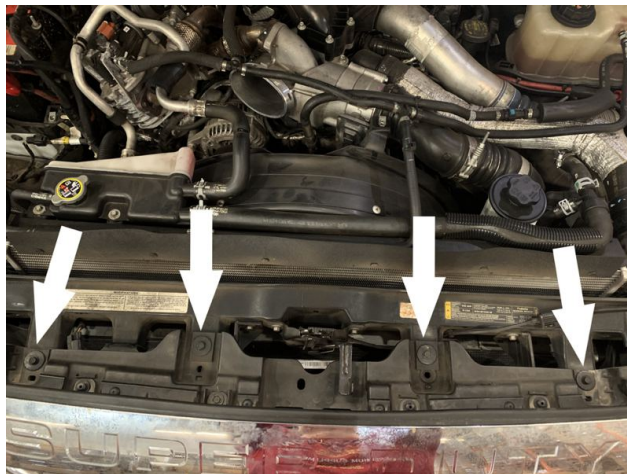

STEP 10

Pull the grill slightly forward and unclip the tabs securing the bottom of the grill to the vehicle. Then pull off the grill.

Tools Required: Flat head Screwdriver



STEP 11

Remove the four screws securing the passenger side headlight assembly to the vehicle and firmly pull the light straight out, unclipping it from the frame of the truck.

Note: The screw securing the bottom of the headlight can be found between the headlight housing and the bumper. A socket extension is required to reach the screw.

Tools Required: Socket Wrench, 10mm Socket



STEP 12

Unplug the three headlight bulbs from the headlight housing.



STEP 13

Feed the headlight bulbs through the hole in the engine bay liner so that they are seated inside the engine bay.



STEP 14

Disconnect the plastic air intake scoop from the frame of the vehicle by removing the series of plastic connectors found around the perimeter of the headlight opening.

Tools Required: Panel Popper



STEP 15

Unclip the headlight harness from the plastic intake scoop and pull the intake scoop up and out of the vehicle. Removing this piece from the vehicle provides space for the large filter included with the open intake kit.



STEP 16

Install the provided grommet (E) into the hole on the intake tube support bracket (D) and attach it to the frame of the vehicle in the position shown. Using one of the screws that was removed in step 7, loosely tighten the bracket down so that there remains some play.

Tools Required: Ratchet, ½" Socket



STEP 17

Gently push the AC line so that it sits under the tube support bracket as shown.

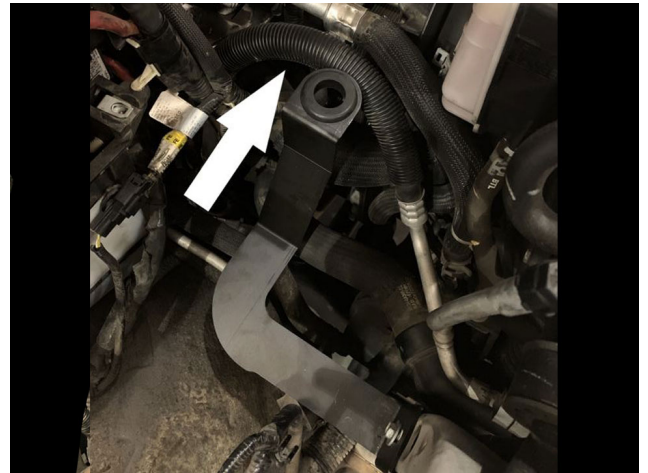

STEP 18

After attaching the provided coupler (G) to the intake tube (C) with a #74 hose clamp (F), install the intake tube into the vehicle by slipping the other end of the coupler around the turbo inlet. Gently guide the prong on the bottom of the tube into the grommet on the tube support bracket. Check the fitment of the bracket and tube and then tighten the bracket fully. This step ensures that the tube support bracket is installed in a position that will seat the tube correctly. After tightening down the bracket, remove the intake tube from the vehicle.

Tools Required: Ratchet, ½" Socket



STEP 19

Assemble the intake tube/filter assembly outside of the vehicle. Do this by attaching the coupler to the oval end of the tube and securing it using a provided #74 hose clamp. Then attach the filter (A) to the intake tube and secure it using a provided #104 hose clamp (B). Put the remaining #74 hose clamp loosely around the remaining side of the coupler. Make sure the location markings on the filter and tube line up to ensure proper alignment of the filter assembly.

Tools Required: 5/16" Nut Driver



STEP 20

Remove the MAF sensor from the stock intake housing.

Tools Required: T20 Torx

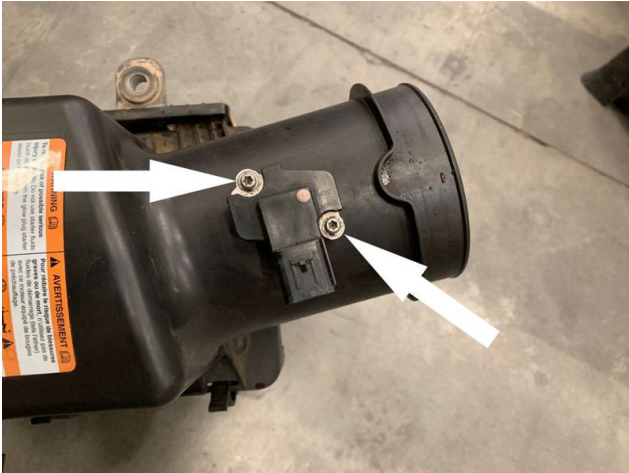

STEP 21

Install the MAF sensor, MAF sensor pad (I) and MAF sensor pad gasket (J) onto the intake tube, securing them to the tube with the provided phillips head screws (H).

Tools Required: Phillips Screwdriver



STEP 22

Install the assembled intake kit into the truck by sliding the intake tube under the aluminum coolant hose so that the tube's coupler slips around the turbo inlet. Secure the assembly by pushing the tube down so that the prong on the bottom side of the tube presses securely in the grommet of the bracket installed in step 18.



STEP 23

Finish securing the kit to the vehicle by tightening the #74 hose clamp over the coupler and around the turbo inlet.

Tools Required: 5/16" Nut Driver

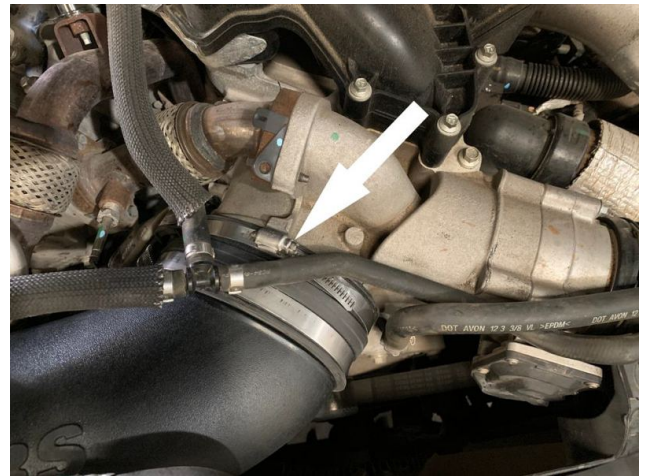

STEP 24

Visually inspect the installation of the intake kit. Make sure the tube is fully seated within the support tube and that the tube did not push out the grommet during installation. The picture provided shows a good place to inspect the tube's installation.

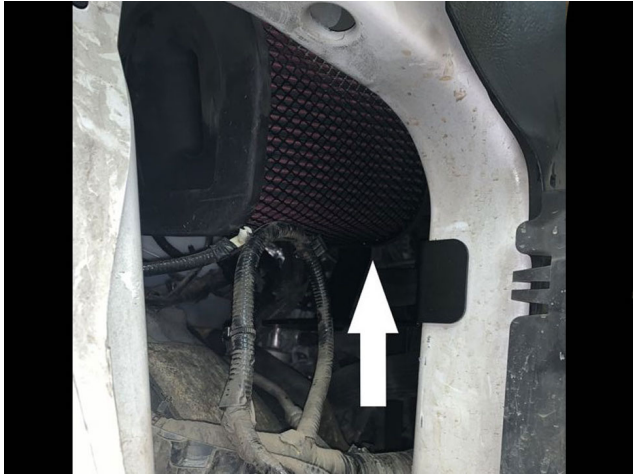

STEP 25

After verifying that the kit has been installed correctly, reconnect the headlight bulbs to the headlight assembly that was removed in step 11.



STEP 26

Reinstall the headlight assembly into the vehicle by pressing the assembly into the frame in order to seat the metal clip. Then replace all four screws that were removed in step 11.

Tools Required: Socket Wrench, 10mm Socket



STEP 27

Reinstall the grill onto the vehicle by aligning the clips on the bottom of the grill with their receptacles and pushing the grill firmly toward the engine bay.



STEP 28

Finish reinstallation of the grill by replacing the four screws removed in step 9.

Tools Required: Socket Wrench, 10mm Socket

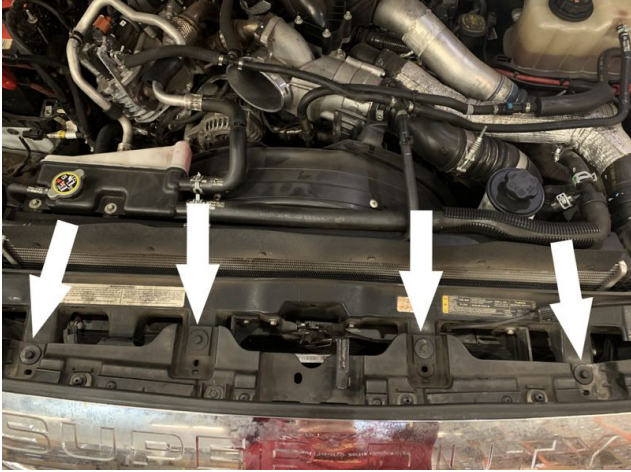

STEP 29

Reroute the MAF sensor harness so that it is positioned between the filter and the battery tray. Attach the provided MAF harness extension (K) to the existing MAF sensor connector by inserting the male end and engaging the red locking clip.



STEP 30

Attach the remaining end of the MAF harness extension to the MAF sensor by inserting the female end and engaging the red locking clip.



STEP 31

Affix the extended MAF cable to the adjacent battery harness with a zip tie (M) to take away some of the slack that exists in the MAF cable. Route the remaining cable under the filter and out of sight.

Tools Required: Scissors



STEP 32

Wrap the metal coolant line that sits on top of the tube with the provided foam wrap (L) to protect your intake tube from being scratched or rubbed by the metal coolant line.



STEP 33

Reconnect the passenger side battery's positive terminal and both battery's negative terminals. Inspect your installation, make sure the kit is properly positioned and all fasteners are secured. S&B Filter recommends keeping all stock parts in case you would ever need to reinstall the stock intake. Affix the ID label near the intake kit. The installation is now complete.

Tools Required: Socket Wrench, 8mm Socket



Performance Testing

- Engage parking brake and start your engine. Listen for abnormal noises. If an air leak is detected, re-inspect hoses and connections as they may need to be repositioned and tightened.
- S&B FILTERS recommends that you keep your OE intake system in the event it is required in the future.
- In order to maintain your warranty, all connections and components must be checked periodically for alignment and for proper tension on all connections. Failure to do so may void your warranty.
- Use only S&B FILTERS cleaning and oil products to service your filter. Using any other brand oil and or cleaners on your S&B air filter may void your warranty.

Warning!

If your vehicle has a Vehicle Emission Control Information decal affixed to the factory airbox, a new replacement label must be obtained and installed in a readily visible position in the engine compartment in order to remain CARB compliant. Failure to do so will prevent the vehicle from passing a smog check. Replacement labels can be ordered from your local dealership. Regulations state that the VECI label shall not be affixed to any equipment which is easily detached from the vehicle. Label placement, under the hood on a painted surface is recommended.