

## INSTALL INSTRUCTIONS FOR 75-6001

**PART#: 75-6001 / 75-6001D**

### Vehicle Application

YEAR: 2017-2019

MAKE: Ford

MODEL: F-250/F-350

ENGINE: 6.7L Powerstroke

### Tools Required

- Socket Wrench
- 7mm, 8mm, 10mm (deep), 13mm Socket
- 5/16" Nut Driver or Flat Blade Screwdriver
- Panel Popper
- T20 Torx
- Phillips Screwdriver
- Scissors
- Heat Gun
- Wire Cutters

### S&B Filter Maintenance

KF-1070 Cotton Cleanable : If the enclosed filter is RED with a black cage, it came pre-oiled from the factory.

KF-1070R Dry Cleanable : If the enclosed filters is WHITE with a black cage, it is a Dry Cleanable filter and can be cleaned up to 10x before discarding. This filter does not require oil. [Click here for the cleaning instructions.](#)

**Note:** Approximate Install Time: 1 Hour  
30 Minutes.

### CARB Status - Pending

CARB EO # Pending

\*Not Legal for use in CA and other states adopting California emissions Standards.

### Before You Start

- Please read the entire product guide before proceeding.
- Ensure all parts are present.
- If you are missing any of the components, call our customer support at (909) 947-0015.
- Do not work on your vehicle while the engine is hot.
- Make sure the engine is turned off and the vehicle is in Park or the Parking Brake is set.

### Related Products

- Cotton Cleanable Filter (KF-1070)
- Dry Cleanable Filter (KF-1070R)
- Cleaning & Oiling Kit (88-0008)

# EXPLODED VIEW - PARTS LIST

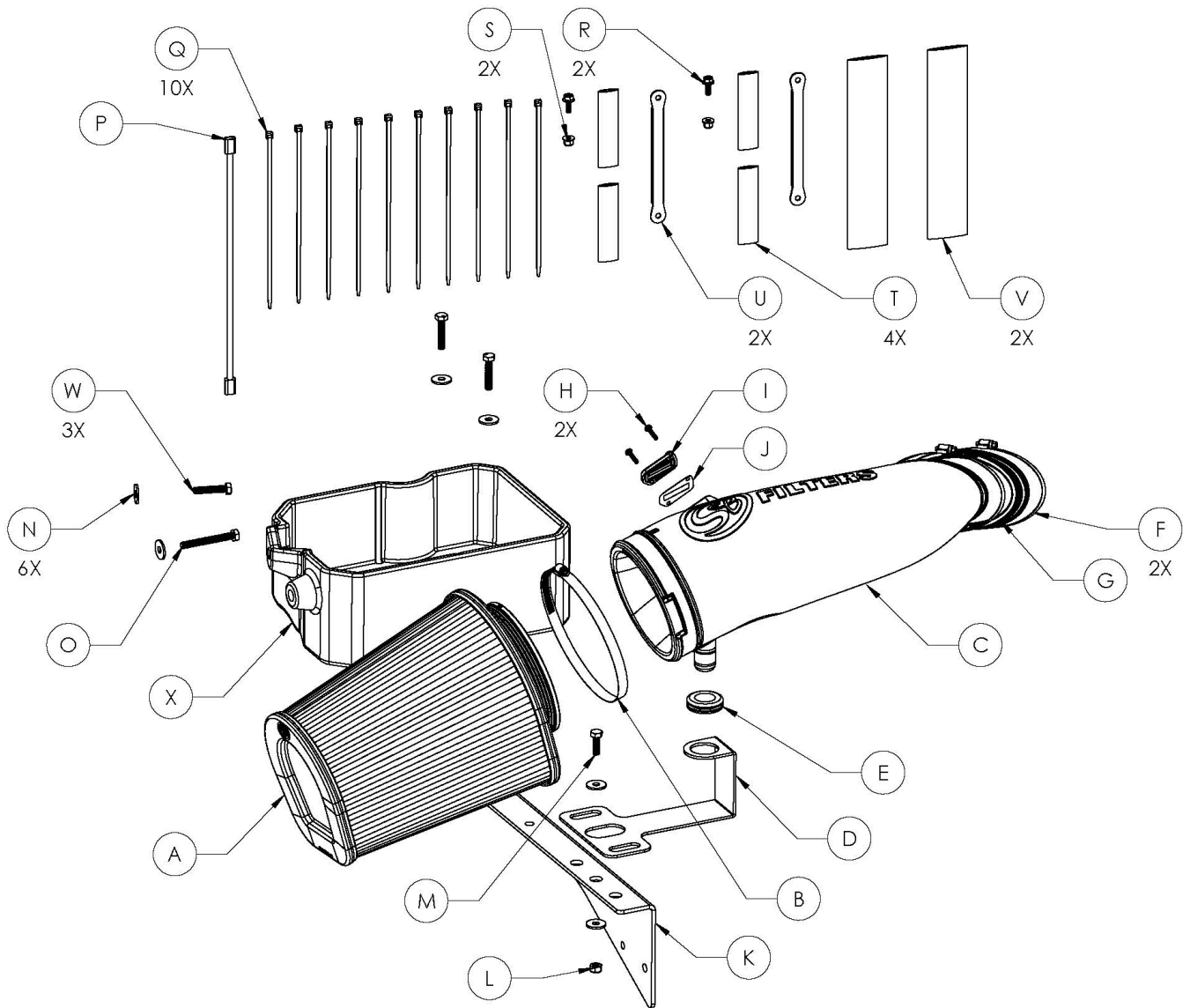

ITEM NO.	PART NUMBER	DESCRIPTION	QTY.	ITEM NO.	PART NUMBER	DESCRIPTION	QTY.
A	KF-1070	Air Filter	1	M	AI1214-00	M8-1.25 x 25mm Long Screw	1
B	AG1012-00	Hose Clamp, #104	1	N	AI1742-00	M8 Fender Washer	6
C	AL1344-00	Inake Tube	1	O	AI2318-00	M8-1.25 x 70mm Long Screw	1
D	AI2174-00	Intake Tube Support Bracket	1	P	AI1481-00	MAF Wire Harness Extension	1
E	AI1368-00	Rubber Grommet	1	Q	AI1750-00	Cable Tie, 9" Long	10
F	AG1009-00	Hose Clamp, #72	2	R	AI2014-00	M6 x 16mm Screw	2
G	AI1523C-00	Straight Coupler	1	S	AI2015-00	M6 Flange Locknut	2
H	AI1837-00	8-32 Thread Size, 3/4" Long Screw	2	T	AI2019-01	1" ID Heat Shrink, Red, 4.0" Long	4
I	AI1822-00	MAF Adapter Pad	1	U	AI2007-00	Battery Cable Extension	2
J	AI1823-00	MAF Gasket	1	V	AI2107-02	Fabric Heat Shrink, Black, 10" Long	2
K	AI1958-CT	Battery Tray Bracket	1	W	AI1163-00	M8-1.25 x 40mm Screw	1
L	AI1736-00	M8 X 1.25 Nylon Insert Locknut	1	X	AI1298T-01	Battery Tray	1



# INSTALLATION STEPS

## STEP 1

With the ignition switched off and the parking brake set, disconnect the negative battery cables on both batteries and positive battery cable on the passenger side only.

**IMPORTANT: Failure to disconnect the battery for a minimum of 2 hours may cause the Check Engine Light to illuminate upon completion of the installation or subsequent operation. DO NOT SKIP THIS STEP!**

Tool Required: 10mm Socket, Socket Wrench.



## STEP 2

Remove the two nuts on the battery hold down bracket, then remove the negative battery cable mounting tab and hold down bracket from the battery. Set the hardware aside they will be reused in Step 27.

Tools Required: 10mm Deep Socket, Socket Wrench



## STEP 3

Remove the battery and battery blanket from the vehicle. The battery is heavy so be extra careful when taking it out. The battery is also filled with battery acid so remember to keep it level to prevent the acid from spilling out the top.

Safety Note: Wear appropriate safety glasses and protective gloves for battery removal and installation.

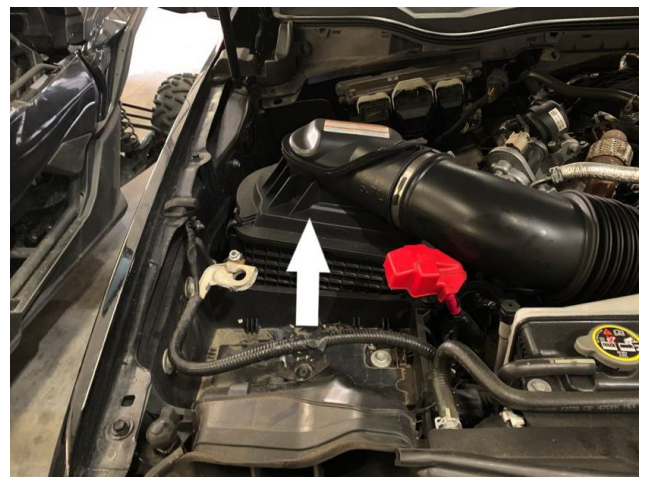

#### STEP 4

Disengage the red locking clip, press down on the tab, then pull out to disconnect the MAF sensor harness from The MAF sensor.

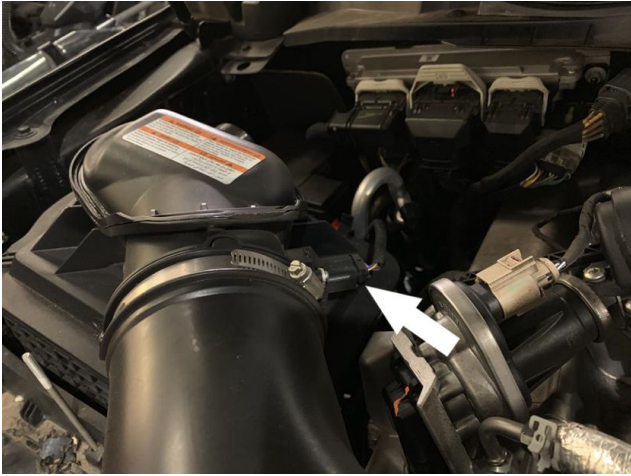

#### STEP 5

Disconnect the hoses attached to the stock intake tube.

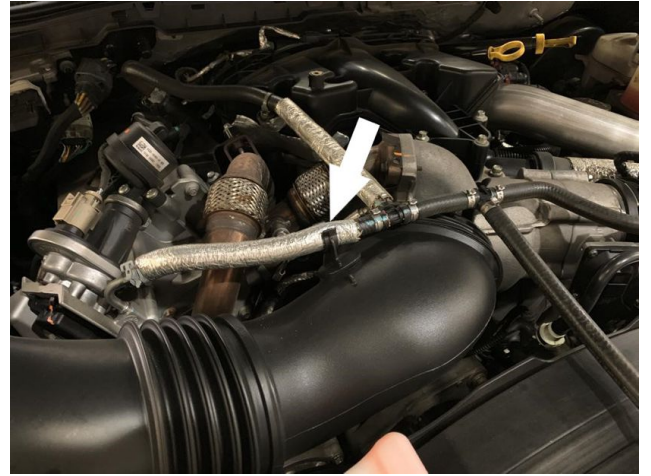

#### STEP 6

Loosen the hose clamp connected to the stock intake box and turbo inlet then remove the stock intake tube from the vehicle.

Tool Required: 7mm Socket, Socket Wrench



#### STEP 7

Remove the two screws securing the stock intake box.

Tool Required: 8mm Socket, Socket Wrench



### STEP 8

Pop out the harness clip attached to the back of the stock intake box.

Tool Required: Panel Popper or Flat Blade Screwdriver.



### STEP 9

Lift up the stock intake box slightly to unseat the prongs from the stock grommets, then remove the stock intake box from the vehicle.

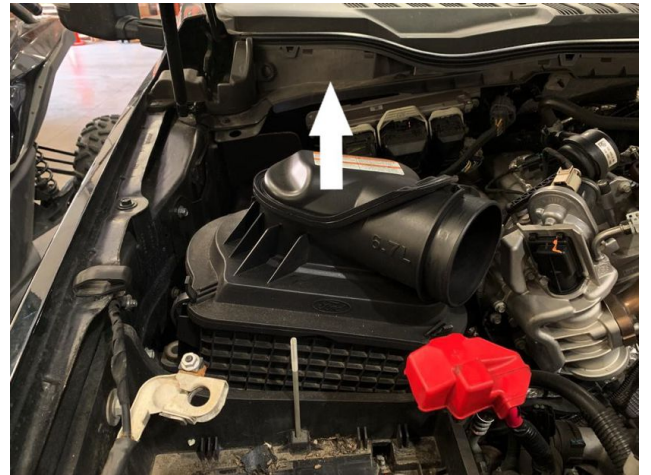

### STEP 10

Pop out the stem and remove the push in rivet from the indicated hole securing the front inlet.

Tool Required: Panel Popper or Flat Blade Screwdriver



### STEP 11

Pop out all the wire harness clips secured to the side of the battery tray.

Tool Required: Panel Popper or Flat Blade Screwdriver

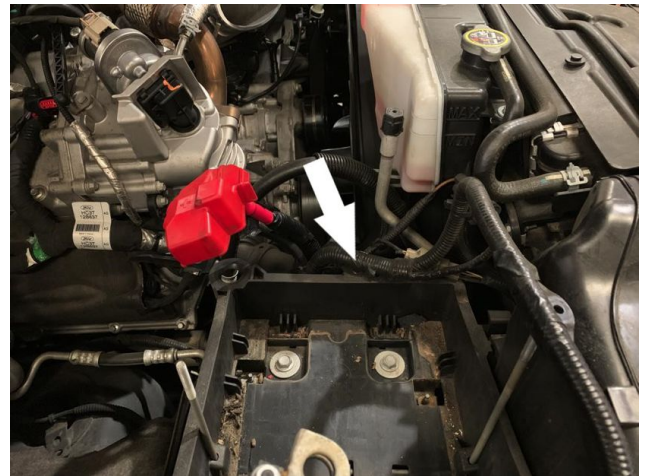

## STEP 12

Pop out the two harness clips on the back of the battery tray.

Tool Required: Panel Popper or Flat Blade Screwdriver

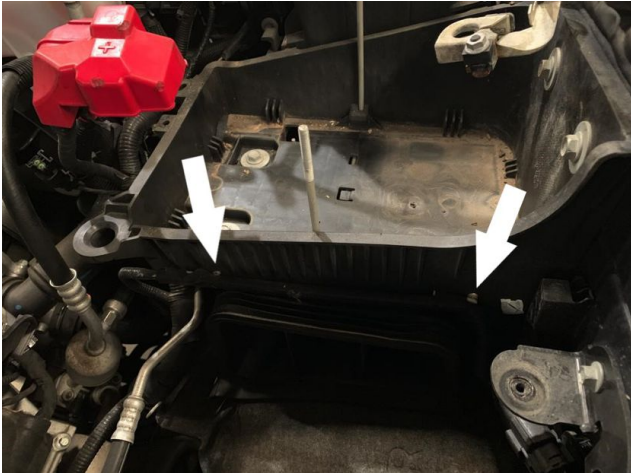

## STEP 13

Remove the four screws then remove the battery tray from the vehicle. Set the screws aside, they will be reused in Step 15.

Tool Required: 13mm Socket, Socket Wrench

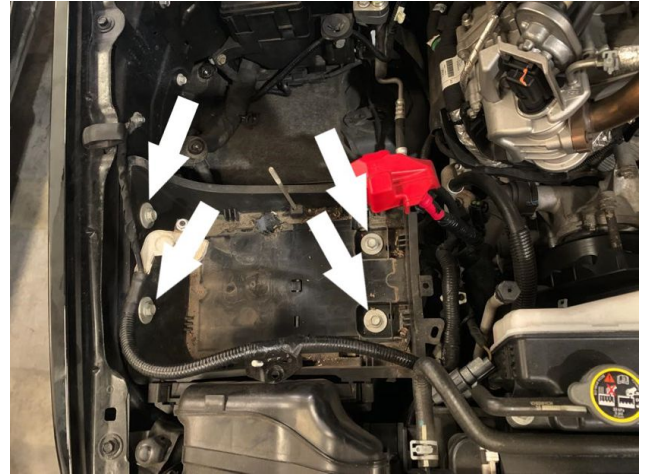

## STEP 14

Remove the two screws, then remove the stock intake box bracket from the vehicle.

Tool Required: 10mm Socket/Wrench

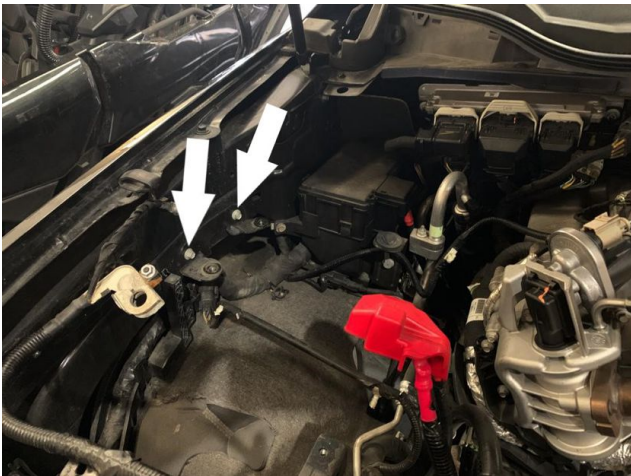

## STEP 15

Remove the AC line clip and electrical harness clip that is attached to the frame before installing the Battery Tray Bracket (K). Make sure that the flange on the battery tray bracket is on the side facing the engine, then align the three mounting holes on the battery tray bracket with the three mounting holes on the frame. Loosely install the M8 Screw (M), Washers (O) and M8 Locknut (L) into the center mounting hole and stock screws from Step 12 into the bracket. This is to prevent the bracket from spinning and keeping all the mounting holes from becoming misaligned. Do not fully tighten yet. Reinsert the AC line clip and electrical harness clip into the holes provided in the side of the battery tray bracket.

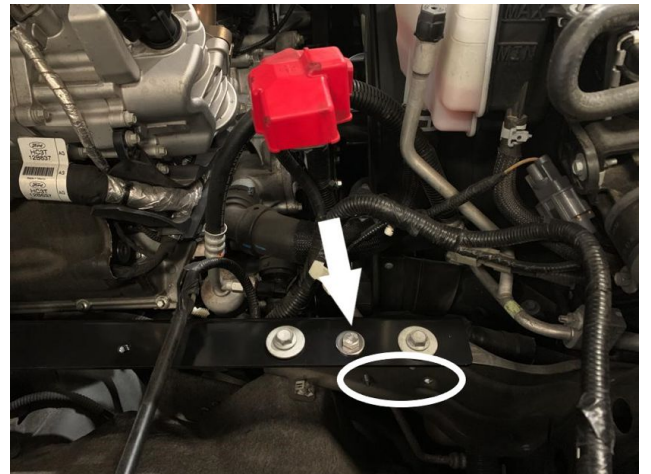

## STEP 16

Remove the stock hold down U-bolt from the stock battery tray by first removing the two screws securing the stock battery tray to the stock intake inlet.

Tool Required: 8mm Socket/Wrench



## STEP 17

Push the locking tabs and lift the stock inlet away from the stock battery tray.



## STEP 18

Pop out the hold down U-bolt from the underside of the battery tray.



## STEP 19

Install the stock hold down U-bolt onto the Battery Tray (Y). The stock hold down U-bolt should be installed as shown below. The longer end should be closest to the longer side of the Battery Tray (Y). Use a Cable Tie (R) through the center of the battery tray to secure the hold down U-bolt.

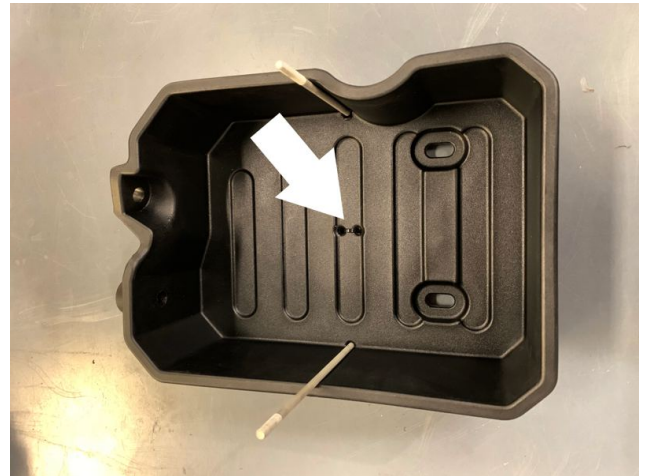



## STEP 20

Check to see if you have one or two ground cables attached to the fender as shown. Some trucks have only the primary ground and others have both the primary and secondary grounds.

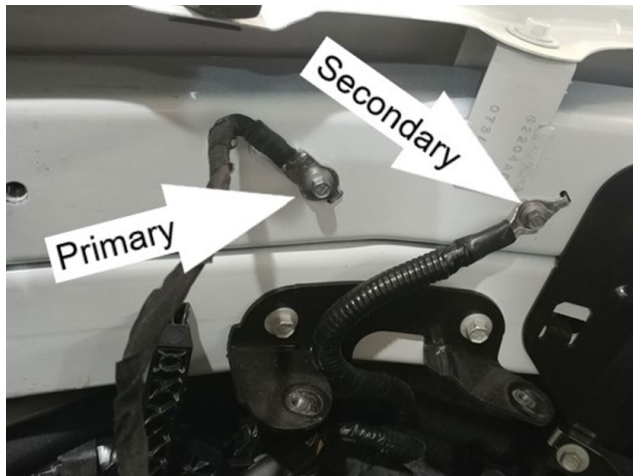

## STEP 21

Remove the grounding bolt that attaches the primary ground to the fender. Set the grounding bolt aside to be used in Step 23.

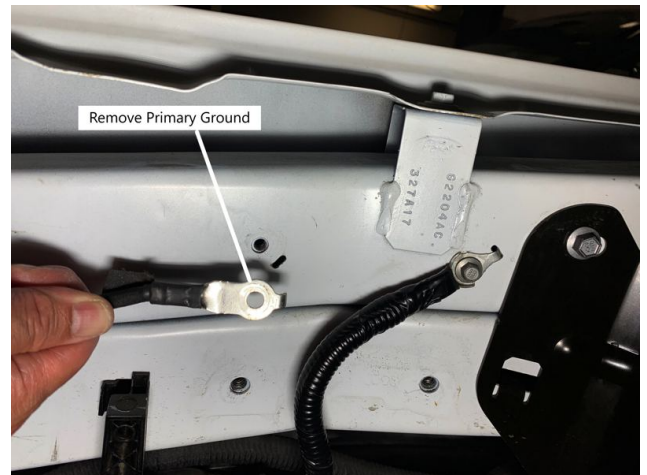

## STEP 22

Do not loosen the screw that holds down the secondary ground. The Battery Tray (Y) is designed to have enough clearance so that the secondary ground does not touch the Battery Tray.

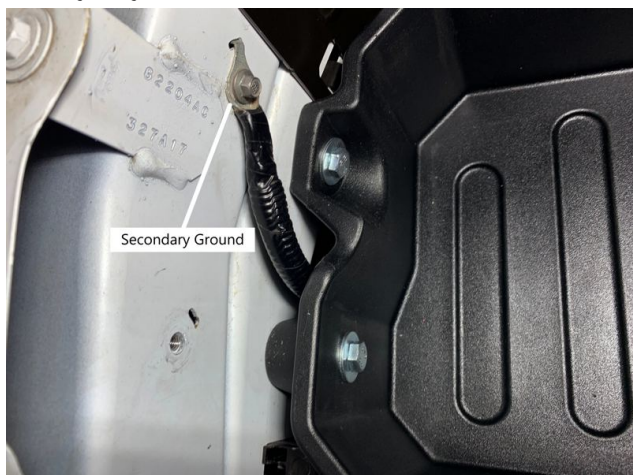

## STEP 23

Align the holes on the Battery Tray (Y) with the holes on the Battery Tray Bracket (K) and side fender wall then tighten with the M8 Screws (X) and Washers (O). Do not overtighten and deform the plastic Battery Tray. Use the longer M8 Screw (P) for going through the long side fender boss on the Battery Tray. Make sure the Battery Tray is not touching the secondary ground.

Tool Required: 13mm Socket/Wrench

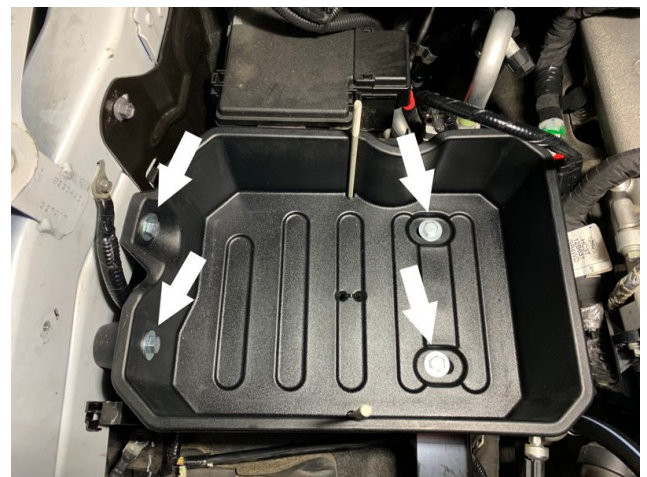

## STEP 24

Fully tighten the center mounting hole with the M8 Screw (M), Washers (O) and M8 Locknut (L) on the Battery Tray Bracket (K) then remove the two stock screws from the bracket.

**Tool Required:** 13mm Socket/Wrench



## STEP 26

Place the battery and battery blanket inside the Battery Tray (Y) as shown. Be careful as the battery is heavy. The battery is also filled with battery acid so remember to keep it level to prevent the acid from spilling out the top. Pay attention to the orientation of the battery where the negative post is closest to the fender and the positive post is closest to the engine. Also make sure the U-bolt is on the outside of the battery blanket.

**Safety Note:** Wear appropriate safety glasses and protective gloves for battery installation.



## STEP 25

Reattach the grounding bolt removed in Step 19 as shown. Re-use the factory grounding bolt to attach the primary ground to its original threaded hole on the fender and torque to factory specifications, 106 lb-in (12Nm). Note: The primary ground should be at an angle with the prong facing away from the fender as shown.

**Tools Required:** 8mm Socket/Wrench, Torque Wrench

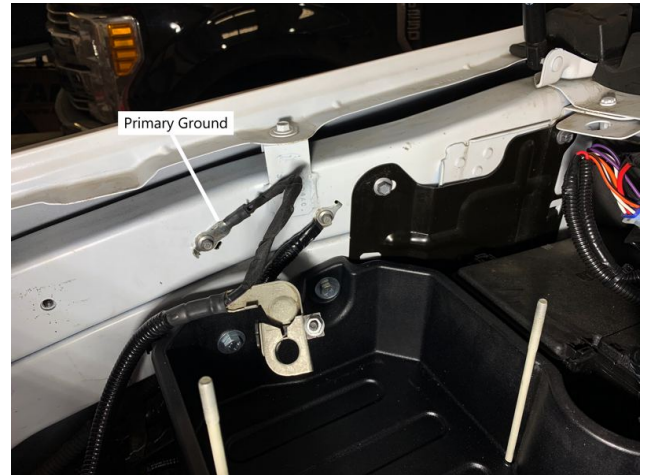

## STEP 27

Secure the battery to the Battery Tray (Y). Install the stock hold down bracket and the negative battery cable mounting tab then reinstall and tighten the nuts removed in Step 2.



## STEP 28

We will now rearrange and flip the tightening mechanism on the negative battery cable terminal. This will allow the terminal to reach the battery post after the battery relocation. First completely remove the nut, screw and wedge then pull out the metal clip then reinstall the metal clip into the longer side on the battery terminal as shown.



## STEP 29

Reinstall the tightening mechanism and then flip the negative cable terminal over. The longer side of the negative battery terminal should be facing the passenger side during installation. Open up the battery terminal diameter by opening up the slit with a screwdriver so it will be easier to get the terminal fully seated onto the battery post.

Tool Required: Flat Blade Screwdriver



## STEP 30

Remove the nut on the positive battery terminal and disconnect the secondary cable. Set the nut aside, it will be reused in Step 33. Note: If you have two secondary positive battery cables, disconnect both from the battery terminal.

Tool Required: 10mm Socket/Wrench

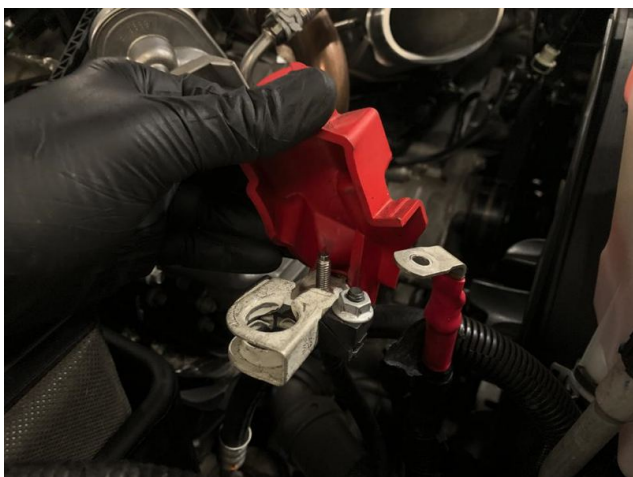

## STEP 31A

Secure one end of the Battery Cable Extension (V) to the secondary battery cable using the M6 Bolt (S) and Flange Nut (T). Keep the metal contacts straight. Torque the M6 Bolt (S) and Flange Nut (T) to 88 lb-in (9.9 Nm).

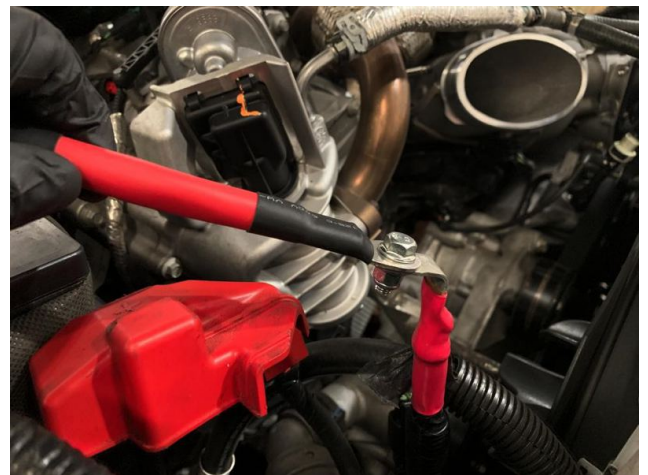

### STEP 31B

Warning: If you have two secondary positive battery cables, install the battery cable extensions separately. Do not attempt to install two secondary positive cables with only one Battery Cable Extension (V). This may lead to a potential fire. Also note the orientation of the extensions when attaching them so that the free end can be stacked flat and back to back as shown.

Tool Required: 10mm Socket/Wrench, Torque Wrench



### STEP 32B

Slide the Fabric Heat Shrink (W) and cover the entire extension including the Heat Shrink (U). Make sure there is no exposed metal or tears after shrinking the Fabric Heat Shrink (W).

Tool Required: Heat Gun

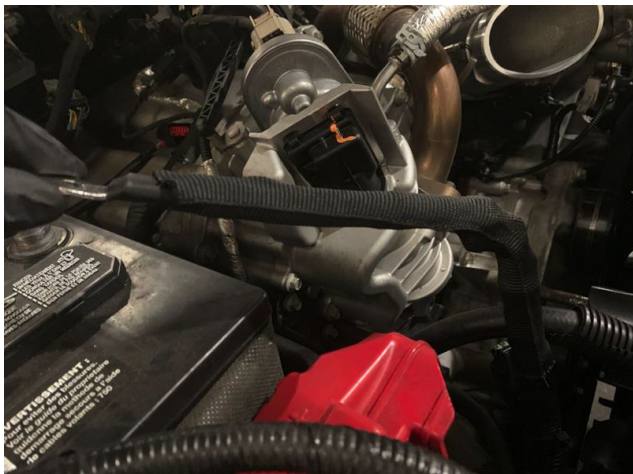

### STEP 32A

Slide the Heat Shrink (U) over the metal contact then shrink the tubing. Make sure there is no exposed metal or tears after shrinking the tube. Repeat the procedure and cover the Heat Shrink (U) with another Heat Shrink (U). Note: If you have two secondary cables, complete the process for each secondary cable individually. Do not use one Heat Shrink (U) for both cables.

Tool Required: Heat Gun



### STEP 33

Reinstall the nut removed in Step 30 to secure the other end of the Battery Cable Extension (V) onto the positive battery terminal. Leave the nut loose. Note: If you have two Battery Extension Cables (V) installed, stack the two cables on top of each other flat, back to back as shown in Step 31b, then reinstall the nut. Tool Required: 10mm Socket/Wrench



### STEP 34

Disconnect the connection between the two wire harnesses shown. Cut the zip tie securing the indicated plug to the negative battery terminal cable.

Tools Required: Scissors, Panel Popper

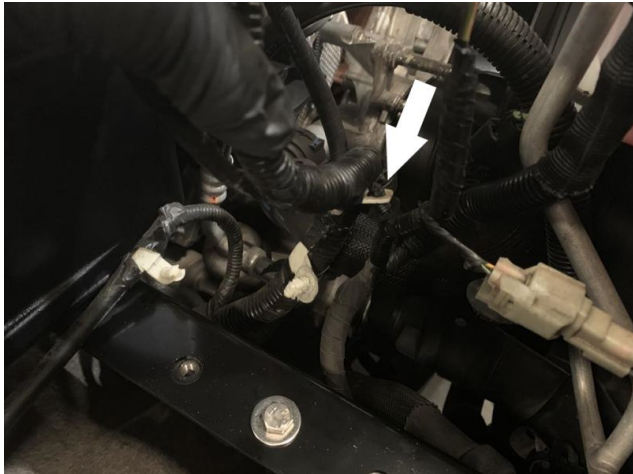

### STEP 35

Install the provided grommet into the hole on the intake tube support bracket.



### STEP 36

Install the tube support bracket into the vehicle, attaching it to the battery tray bracket using the two loose M8 screws that were used to initially attach the battery tray bracket to the vehicle. Do not tighten these screws all the way so that the bracket still has some play.

Tools Required: 13mm Socket, Socket Wrench

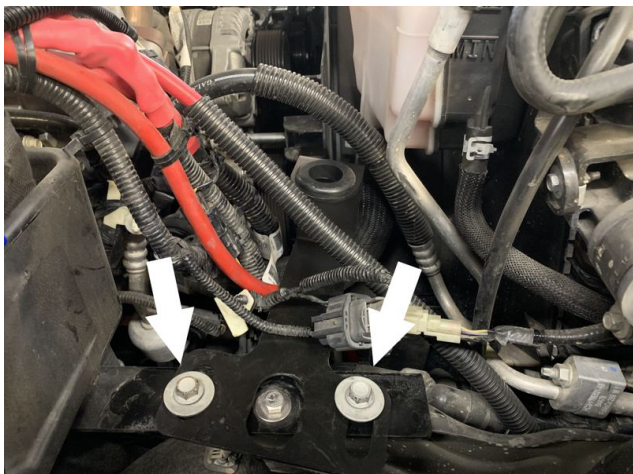

### STEP 37

After attaching the provided coupler (G) to the intake tube (C) with a #74 hose clamp (F), install the intake tube into the vehicle by slipping the other end of the coupler around the turbo inlet. Gently guide the prong on the bottom of the tube into the grommet on the tube support bracket. Check the fitment of the bracket and tube and then tighten the bracket fully. This step ensures that the tube support bracket is installed in a position that will seat the tube correctly. After tightening down the bracket, remove the intake tube from the vehicle.



### STEP 38A

Assemble the intake tube/filter assembly outside of the vehicle. Do this by attaching the coupler to the oval end of the tube and securing it using a provided #74 hose clamp (F). Then attach the filter to the intake tube and secure it using a provided #104 hose clamp (B).

**Tools Required:** Ratchet, 8mm Socket



### STEP 38B

Make sure the location markings on the filter and tube line up to ensure proper alignment of the filter assembly.



### STEP 39

Remove the MAF sensor from the stock intake housing.

**Tools Required:** T20 Torx

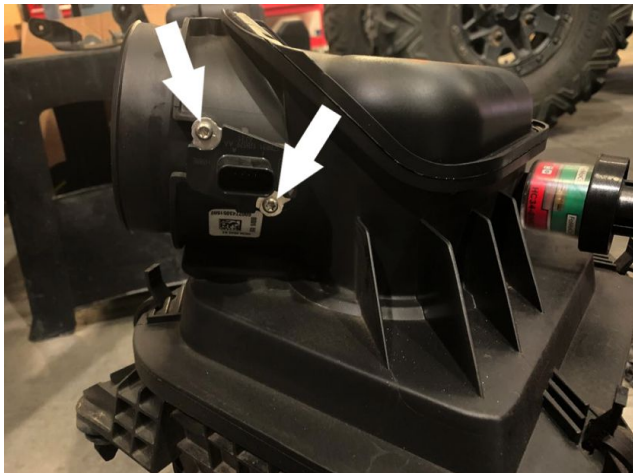

### STEP 40

Install the MAF sensor, MAF sensor pad (I) and MAF sensor pad gasket (J) onto the intake tube, securing them to the tube with the provided phillips head screws.

**Tools Required:** Phillips head screwdriver



## STEP 41

Install the assembled intake kit into the truck by sliding the intake into the vehicle so that the tube coupler slips around the turbo inlet. Secure the assembly by pushing the tube down so that the prong on the bottom side of the tube sits securely in the grommet of the bracket installed in step 9. Finish securing the kit to the vehicle by tightening the remaining #74 bracket over the coupler and around the turbo inlet.

Note: If the indicated AC tube is in the way of the intake assembly during installation, gently bend it out of the way so that it does not hit any part of the filter.

**Tools Required:** Ratchet, 8mm Socket.

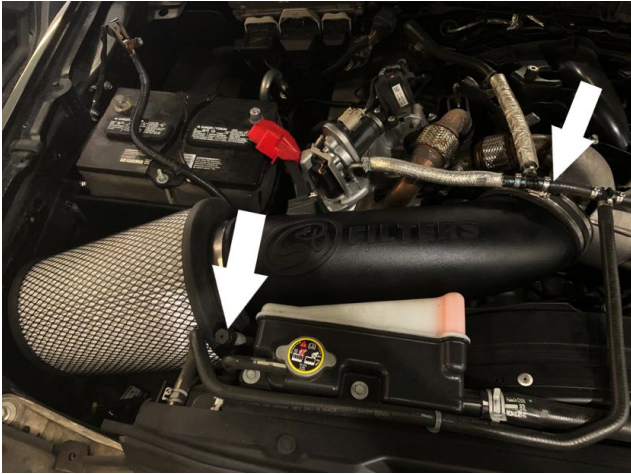

## STEP 42

Attach the provided MAF harness extension (Q) to the existing MAF sensor connector by inserting the male end and engaging the red locking clip.



## STEP 43

Attach the remaining end of the MAF harness extension (Q) to the MAF sensor by inserting the female end and engaging the red locking clip. Route the slack of the MAF cable underneath the positive battery terminal cable.



## STEP 44A

Install the positive terminal on the positive battery post. Remove the terminal clamp nut assembly and rotate it to the other side of the terminal as shown by the white arrow. Moving the terminal clamp nut will allow the positive cables and extensions to be as close as possible to the side of the battery.



## STEP 45

Place the positive terminal cover over the positive terminal and verify that the battery cables and extensions are as close as possible to the side of the battery so that all cables and wires are away from any hot components or moving parts that could potentially damage the cables or wires.

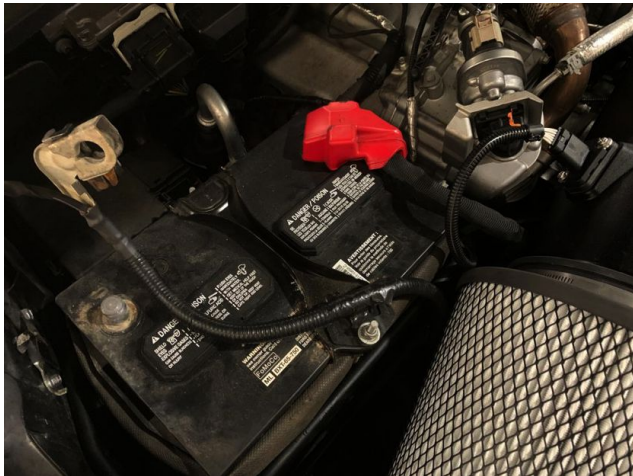

## STEP 44B

Now position the terminal so that the battery cables and Battery Cable Extension(s) (V) are as close as possible to the side of the battery so that the cables do not come in contact with any hot components or moving parts. Torque the terminal clamp nut to factory specifications, 80 lb-in (9 Nm). Torque the battery cable nut to factory specifications, 80 lb-in (9 Nm).

Tools Required: 10mm Deep Socket/Wrench, Torque Wrench



## STEP 46

Install the negative terminal on the negative battery post as shown. Tighten the terminal clamp nut and torque to factory specification, 80 lb-in (9 Nm). Do the same to the driver's side battery.

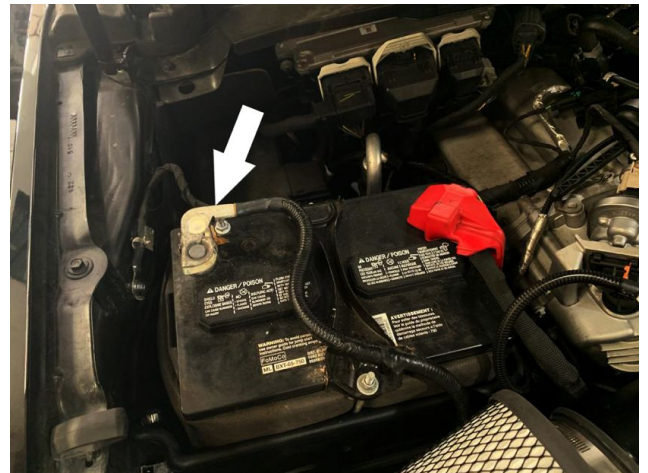



## STEP 47

Zip tie the slack of the MAF cable to the indicated places to make sure it does not move during operation of the vehicle.



## STEP 48

Inspect your installation, make sure the kit is properly positioned and all fasteners are secured. S&B Filters recommends keeping all stock parts in case you would ever need to reinstall the stock intake. Affix the ID label near the intake kit. The installation is now complete.



## Performance Testing

- Engage parking brake and start your engine. Listen for abnormal noises. If an air leak is detected, re-inspect hoses and connections as they may need to be repositioned and tightened.
- S&B FILTERS recommends that you keep your OE intake system in the event it is required in the future.
- In order to maintain your warranty, all connections and components must be checked periodically for alignment and for proper tension on all connections. Failure to do so may void your warranty.
- Use only S&B FILTERS cleaning and oil products to service your filter. Using any other brand oil and or cleaners on your S&B air filter may void your warranty.

## Warning!

If your vehicle has a Vehicle Emission Control Information decal affixed to the factory airbox, a new replacement label must be obtained and installed in a readily visible position in the engine compartment in order to remain CARB compliant. Failure to do so will prevent the vehicle from passing a smog check. Replacement labels can be ordered from your local dealership. Regulations state that the VECI label shall not be affixed to any equipment which is easily detached from the vehicle. Label placement, under the hood on a painted surface is recommended.